



CONTRACTOR	
PROJECT	DATE
PREPARED BY	MODEL : L820-R

SERIES SPECIFICATIONS

20A 480V/AC 2POLE 3WIRE LOCKING DEVICE RECEPTACLE

- Durable fiberglass reinforced nylon body construction
- Notched terminal plates bit wire to ensure a positive bond
- Compact body design allowing more wire room in the box
- One piece copper alloy contact reduces heat build up and provides superior heat retention



LINE DRAWING

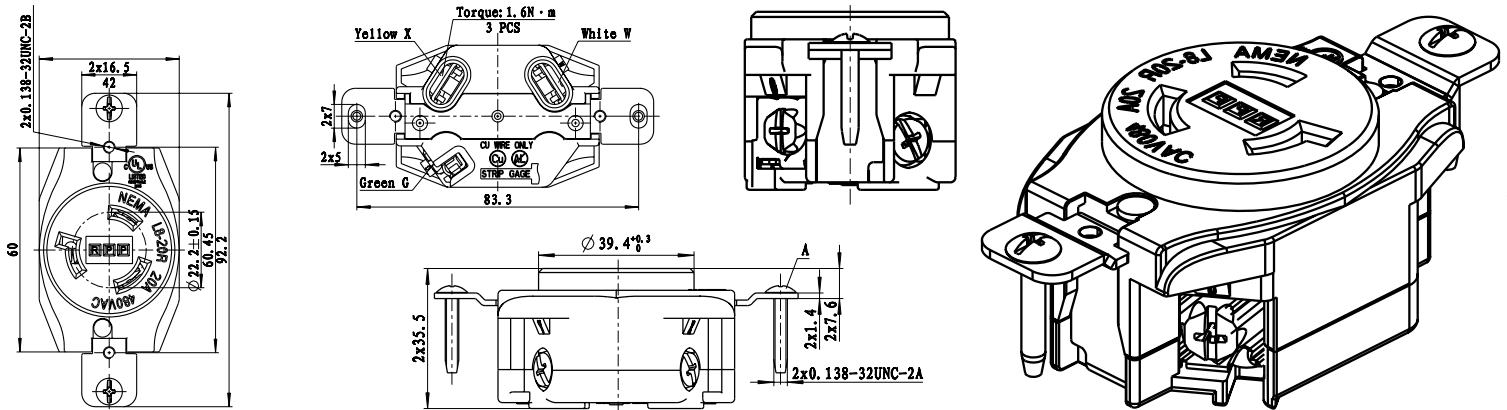

CONSTRUCTION

Finish
Black

NEMA Configuration
L8-20R

Wires
3

ELECTRICAL SPECIFICATIONS

Voltage
480VAC

Amperage
20A

Grounding
Yes

Phase
Single

Poles
2

APPLICATION AND PERFORMANCE SPECIFICATION INFORMATION IS SUBJECT TO CHANGE WITHOUT NOTIFICATION



404 NW ENTERPRISE DR. PORT ST. LUCIE, FL 34986 | 772.408.5213 | WWW.RPP-USA.COM



CONTRACTOR	
PROJECT	DATE
PREPARED BY	MODEL : L820-R

CERTIFICATIONS/WARRANTY

Listing
c-UL-us Listed

Warranty
Guaranteed for one year from the purchase date of the product, against mechanical defects in manufacturing.

ORDERING INFORMATION

Part Number: L820-R

Box Qty : 10

Weight (Lbs) : 0.200

Carton Qty. : 60

IMS Code : 0292-9896

APPLICATION AND PERFORMANCE SPECIFICATION INFORMATION IS SUBJECT TO CHANGE WITHOUT NOTIFICATION



404 NW ENTERPRISE DR. PORT ST. LUCIE, FL 34986 | 772.408.5213 | WWW.RPP-USA.COM