



CONTRACTOR	
PROJECT	DATE
PREPARED BY	MODEL : L1530-R

SERIES SPECIFICATIONS

30A 3 POLE 4 WIRE 3PHASE 250V LOCKING RECEPTACLE

- Durable fiberglass reinforced nylon body construction
- Notched terminal plates bit wire to ensure a positive bond
- Compact body design allowing more wire room in the box
- One piece copper alloy contact reduces heat build up and provides superior heat retention



LINE DRAWING

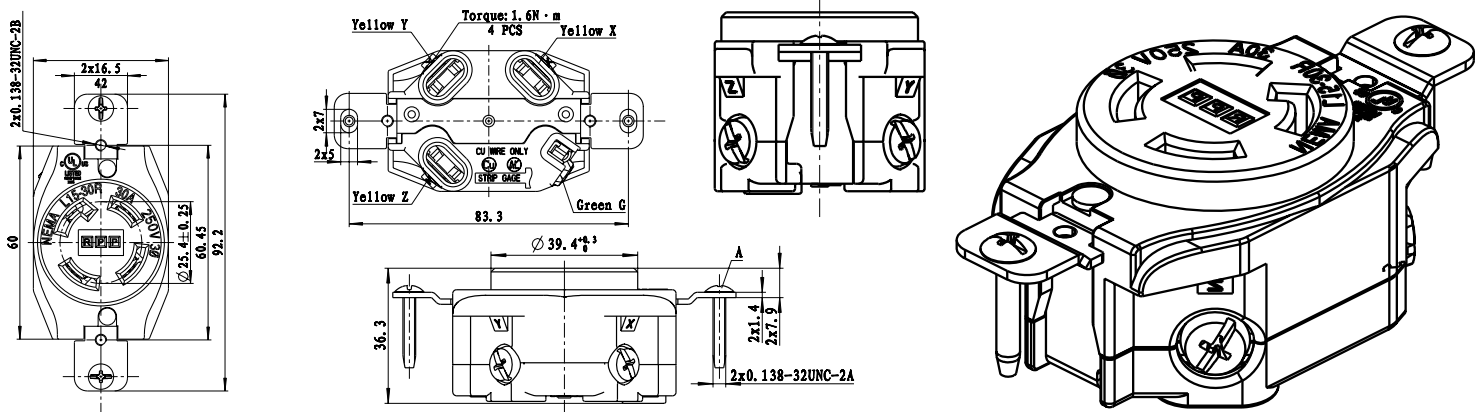

CONSTRUCTION

Finish
Black

NEMA Configuration
L15-30R

Wires
4

ELECTRICAL SPECIFICATIONS

Voltage
250VAC

Amperage
30A

Grounding
Yes

Phase
3 Phase

Poles
3

APPLICATION AND PERFORMANCE SPECIFICATION INFORMATION IS SUBJECT TO CHANGE WITHOUT NOTIFICATION



404 NW ENTERPRISE DR. PORT ST. LUCIE, FL 34986 | 772.408.5213 | WWW.RPP-USA.COM



CONTRACTOR	
PROJECT	DATE
PREPARED BY	MODEL : L1530-R

CERTIFICATIONS/WARRANTY

Listing
c-UL-us Listed

Warranty
Guaranteed for one year from the purchase date of the product, against mechanical defects in manufacturing.

ORDERING INFORMATION

Part Number: L1530-R

Box Qty : 10

Weight (Lbs) : 0.200

Carton Qty. : 60

IMS Code : 0292-9932

APPLICATION AND PERFORMANCE SPECIFICATION INFORMATION IS SUBJECT TO CHANGE WITHOUT NOTIFICATION



404 NW ENTERPRISE DR. PORT ST. LUCIE, FL 34986 | 772.408.5213 | WWW.RPP-USA.COM